

VANTAGE

**1/10 SCALE 4WD READY-TO-RUN BRUSHED OR
BRUSHLESS ELECTRIC MOTOR POWERED RACING BUGGY**



COMPONENT AND UPGRADE PARTS LISTING

www.ftx-rc.com



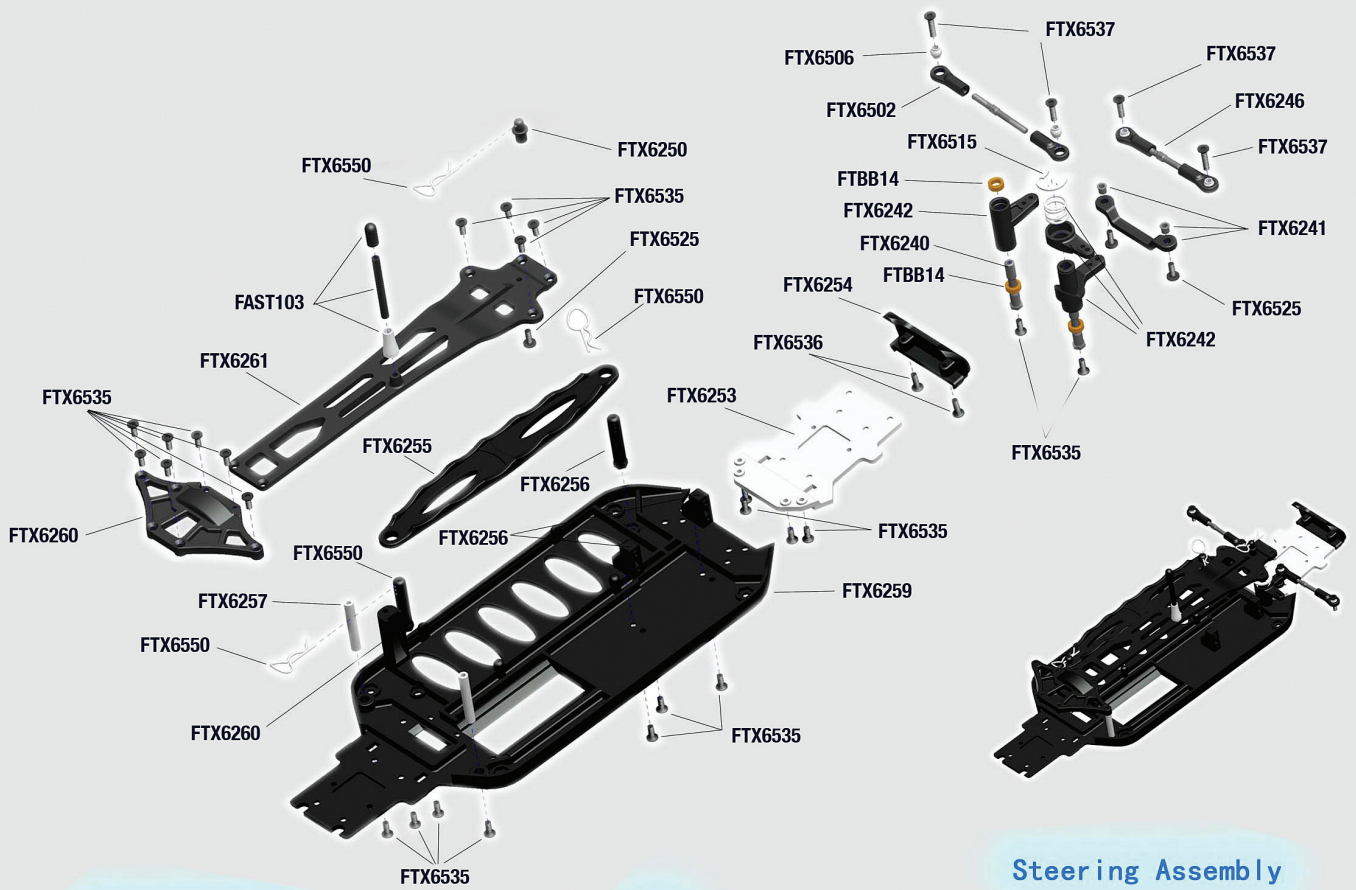

Rear Assembly

ESC

Steering Assembly

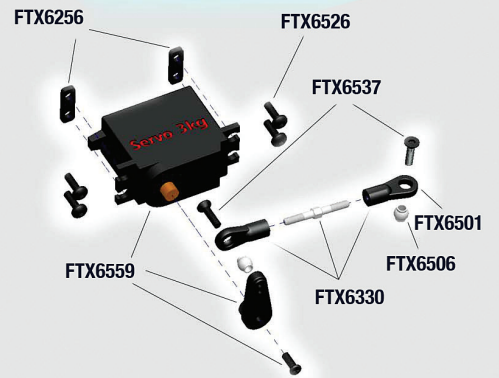
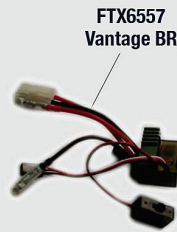

Motor Assembly

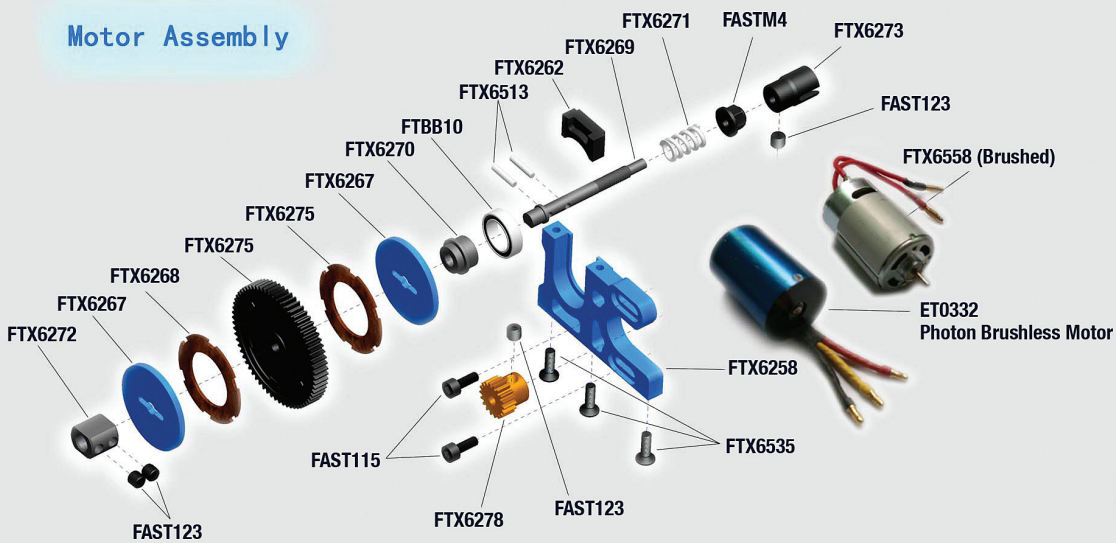

FRONT & REAR SHOCK ASSEMBLY

Front Shocks

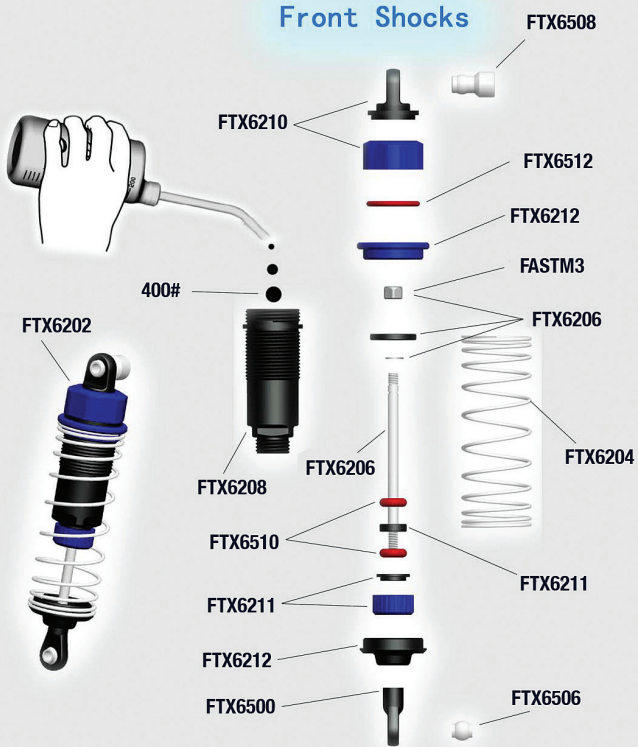

Rear Shocks

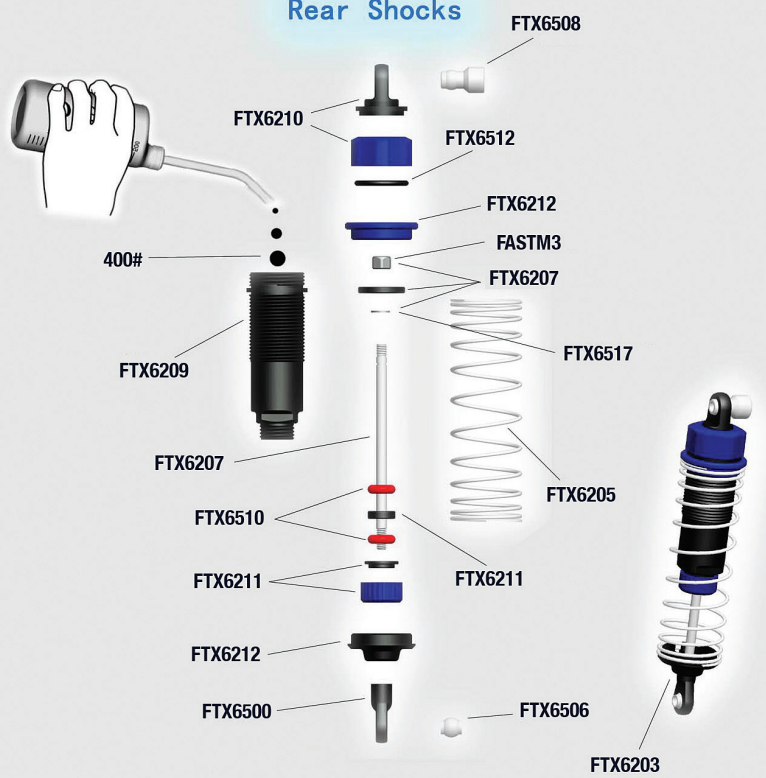

Steering Servo

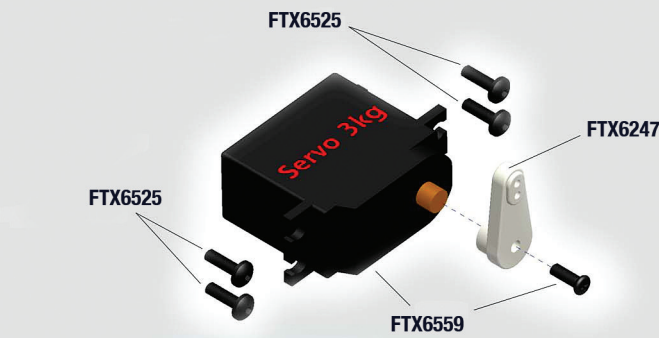

Front Tyres

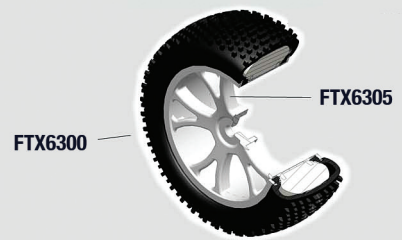

Rear Tyres

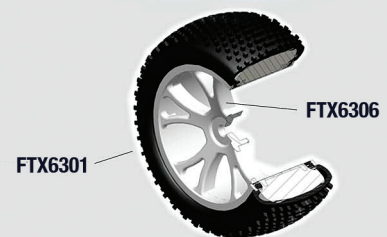

B O M

TYPE	ICON	SPEC	QTY
Round Head Self Tapping Hex Screw		2*10	4
Button Head Hex Screw		M3*6	4
		M3*12	2
Cap Head Hex Screw		M3*10	10
		M3*12	3
Flat Head Hex		M3*14	4
		M3*18	2
		M3*36	2
		M4*4	1
Set Screw		M4*10	2
		M4*10	2
Ring Self Tapping Screw		3*4	2
Washer		ø6*ø3.1*0.2	2
Nylon Lock Nut		M3	2
E clip		ø2.5	5
O'Ring		ø8.05*ø4.55*ø1.55	4
		ø8*ø3*ø2.5	4
		ø15.6*ø12.6*ø1.5	2
Ball Bearing		ø15*ø10*4	2
		ø10*ø5*4	6

Front Assembly

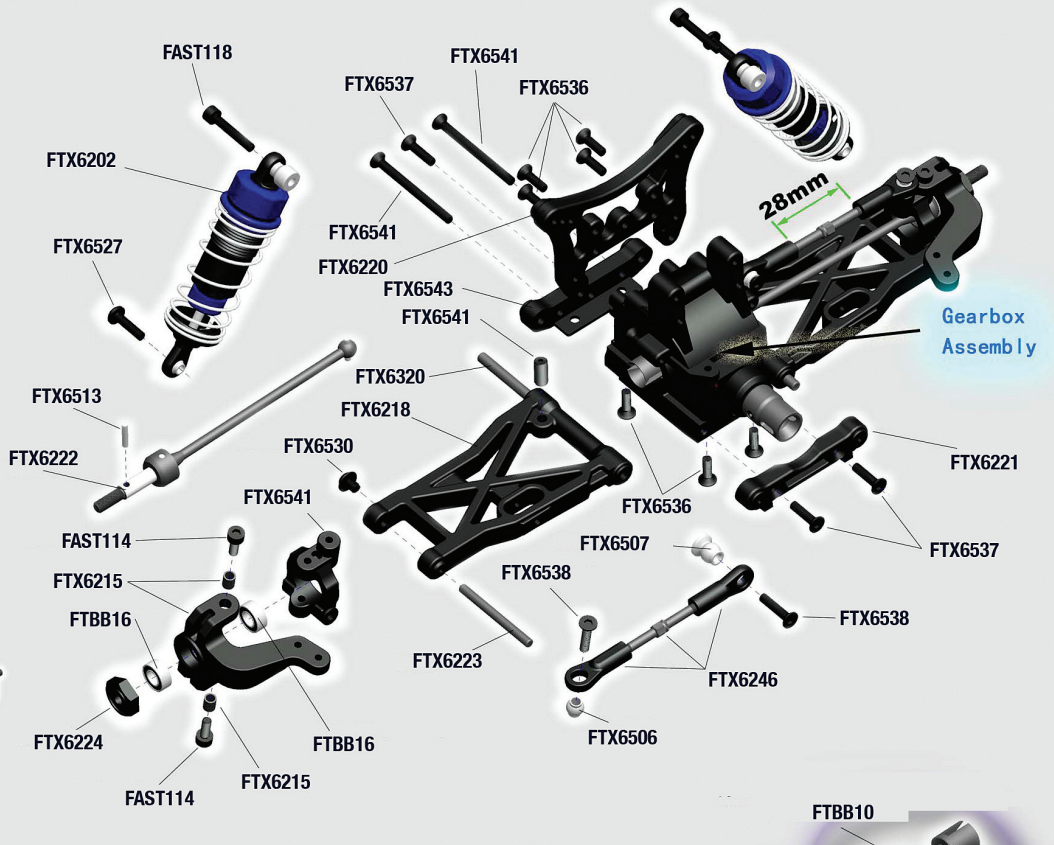

Gearbox Assembly

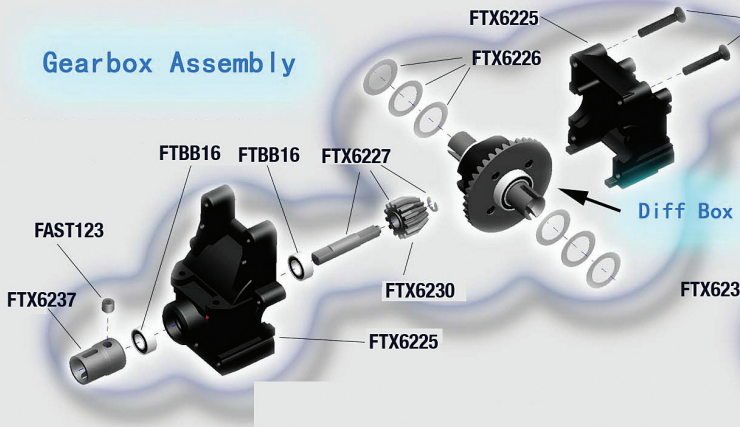

Diff Box

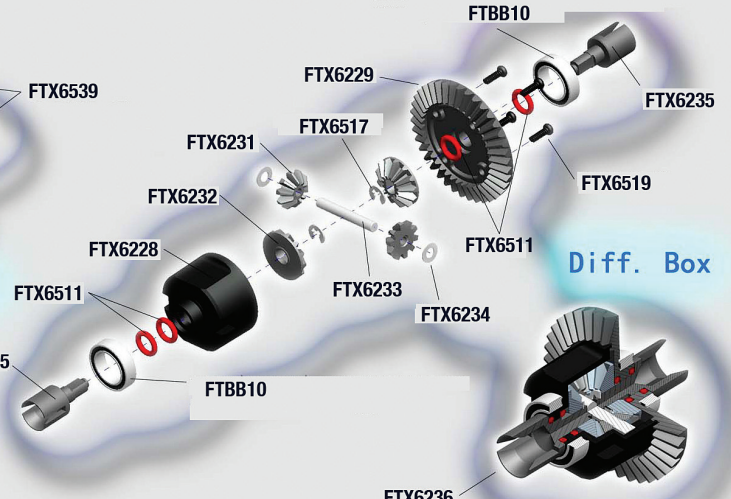

Diff. Box

Rear Assmbeily

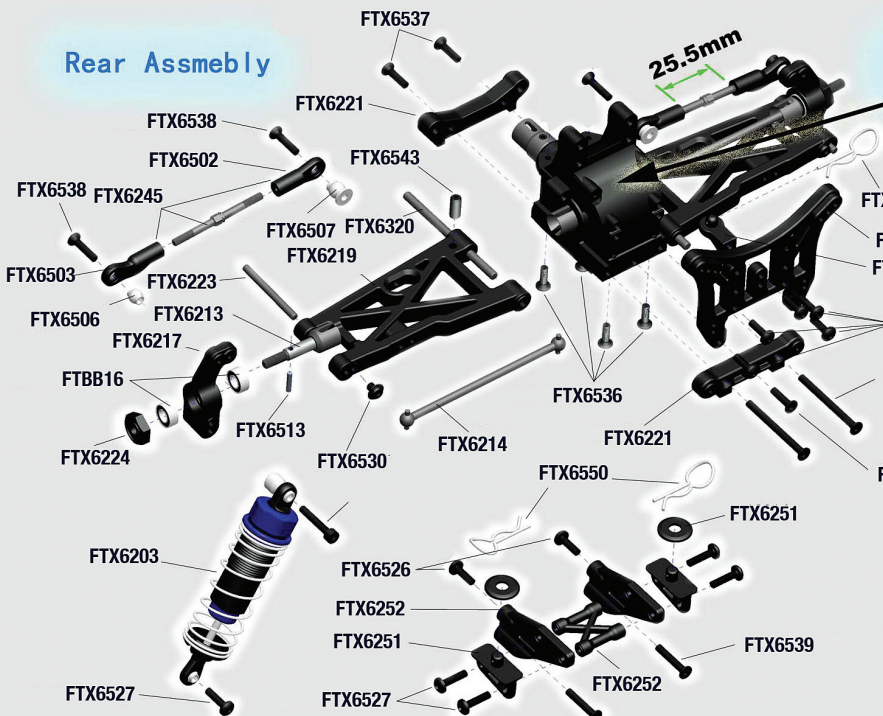



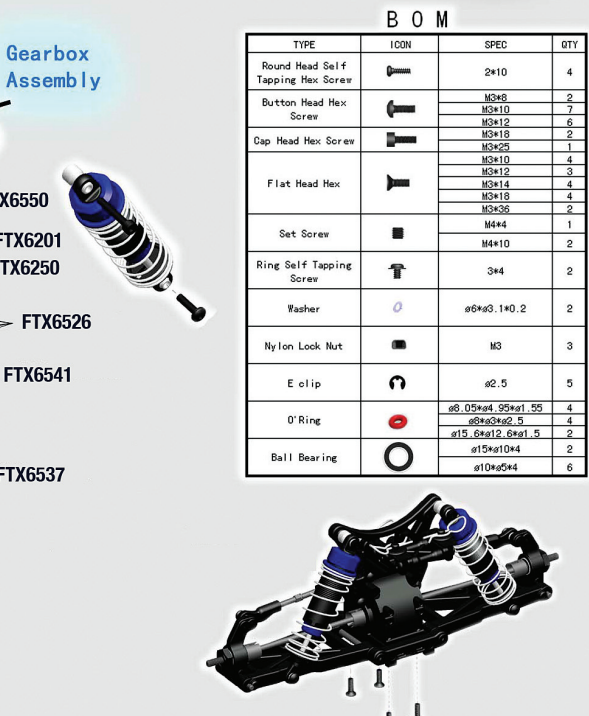











Gearbox Assembly

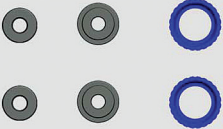



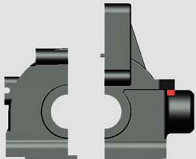







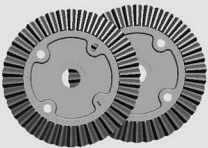

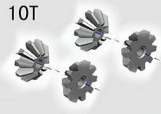





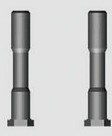

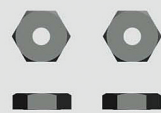
B O M

TYPE	ICON	SPEC	QTY
Round Head Self Tapping Hex Screw		2*10	4
Button Head Hex Screw		M3*6	2
		M3*10	7
Cap Head Hex Screw		M3*12	6
		M3*18	1
Flat Head Hex		M3*25	4
		M3*10	3
		M3*12	4
		M3*18	4
Set Screw		M3*36	2
		M4*4	1
Ring Self Tapping Screw		M4*10	2
Washer		ø6*ø3.1*0.2	2
Nylon Lock Nut		M3	3
E clip		ø2.5	5
O'Ring		ø8.05*ø4.55*ø1.55	4
		ø8*ø3*ø2.5	4
		ø15.6*ø12.6*ø1.5	2
Ball Bearing		ø15*ø10*4	2
		ø10*ø5*4	6

Common Part List

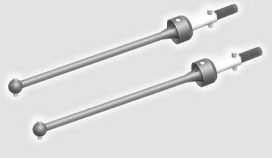
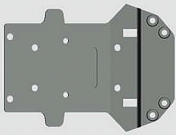
<p>Front Shock Tower 1pc</p>  <p>FTX6200</p>	<p>Rear Shock Tower 1pc</p>  <p>FTX6201</p>	<p>Front Shocks 2pc</p>  <p>FTX6202</p>	<p>Rear Shock Tower 2pc</p>  <p>FTX6203</p>
<p>Front Shock Spring 2pc</p>  <p>FTX6204</p>	<p>Rear Shock Spring 2pc</p>  <p>FTX6205</p>	<p>Front Shock Shaft & Piston Set 2sets</p>  <p>FTX6206</p>	<p>Rear Shock Shaft & Piston Set 2sets</p>  <p>FTX6207</p>
<p>Front Shock Body 2pc</p>  <p>FTX6208</p>	<p>Rear Shock body 2pc</p>  <p>FTX6209</p>	<p>Shock Upper Cap 2sets</p>  <p>FTX6210</p>	<p>Shock Lower Caps 2sets</p>  <p>FTX6211</p>
<p>Shock Lower holder & Adjust Ring 2sets</p>  <p>FTX6212</p>	<p>Steering Knuckle Arm 1set</p>  <p>FTX6215</p>	<p>Uprights 2pc</p>  <p>FTX6216</p>	<p>Rear Hub Carrier 2pc</p>  <p>FTX6217</p>
<p>Rear Drive Shaft 2pc</p>  <p>FTX6213</p>	<p>Front Susp. Holders 2pc</p>  <p>FTX6220</p>	<p>Rear Susp. Holders 2pc</p>  <p>FTX6221</p>	<p>Gearbox Housing Set 2pcs</p>  <p>FTX6225</p>
<p>Diff 16T Gear Washer 6pcs</p>  <p>FTX6226</p>	<p>Diff. Drive Gear w/pin 2sets</p>  <p>FTX6227</p>	<p>Diff Gearbox Set 1set</p>  <p>FTX6236</p>	<p>Diff Case 2pcs</p>  <p>FTX6228</p>

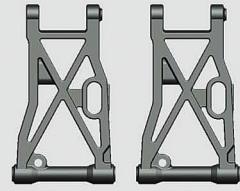
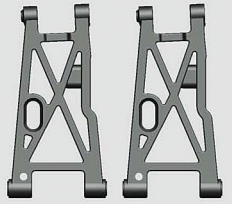
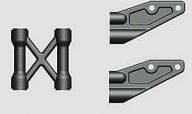
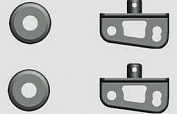















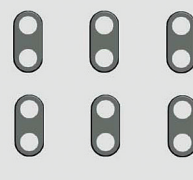



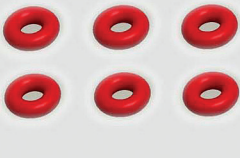

Common Part List

<p>Diff Drive Spur Gear 2pcs</p>  <p>38T</p> <p>FTX6229</p>	<p>Diff Drive Gear 2pcs</p>  <p>13T</p> <p>FTX6230</p>	<p>Diff Bevel Gear S. 4pcs</p>  <p>10T</p> <p>FTX6231</p>	<p>Diff Bevel Gear B. 4pcs</p>  <p>13T</p> <p>FTX6232</p>
<p>Diff Pin 2pcs</p>  <p>FTX6233</p>	<p>Washer 6pcs</p>  <p>FTX6234</p>	<p>Diff Drive Cup 4pcs</p>  <p>FTX6235</p>	<p>Center Coupler 3pcs</p>  <p>FTX6237</p>
<p>Servo Saver Post 2pcs</p>  <p>FTX6240</p>	<p>Steering Ackerman</p>  <p>FTX6241</p>	<p>Wheel Hub 4pcs</p>  <p>FTX6224</p>	<p>Antenna Pipe Set 2sets</p>  <p>FAST103</p>
<p>Servo Saver (EP) 1set</p>  <p>FTX6242</p>	<p>Front buggy tyre set 2sets</p>  <p>FTX6300W FTX6300B</p>	<p>Rear buggy tyre set 2sets</p>  <p>FTX6301W FTX6301B</p>	<p>Front Rim 2pcs Rear Rim 2pcs</p>  <p>FTX6305 (FR) FTX6306 (RE)</p>
<p>Front CVD 2sets</p>  <p>FTX6222</p>	<p>Chassis Front Part 1pc</p>  <p>FTX6253</p>	<p>Front Bumper buggy 1pc</p>  <p>FTX6254</p>	<p>Front Lower Susp. Arm 2pc</p>  <p>FTX6218</p>
<p>Rear Lower Susp. Arm 2pc</p>  <p>FTX6219</p>	<p>Wing Bracket 1set</p>  <p>FTX6252</p>	<p>Wing Holder 1set</p>  <p>FTX6251</p>	<p>Buggy Body Mount 1set</p>  <p>FTX6250</p>



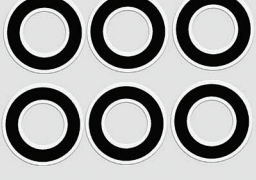
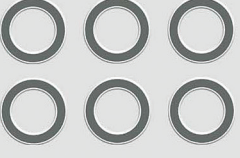

















Part List

<p>Servo Linkage 1pc</p>  <p>FTX6243</p> <p>Front Upper Susp. Arm 2sets</p>  <p>FTX6244</p>	<p>Rear Upper Susp. Arm 2sets</p>  <p>FTX6245</p>	<p>Steering Arm 2sets</p>  <p>FTX6246</p>	<p>Central Dongbone F. 1pc</p>  <p>FTX6214</p>
<p>Battery Cover (EP) 1pc</p>  <p>FTX6255</p>	<p>Battery Post 2sets</p>  <p>FTX6256</p>	<p>Post for Rear Spur Gear Cover 2pc</p>  <p>FTX6257</p>	<p>Motor Mount (EP) 1pc</p>  <p>FTX6258</p>
<p>Slipper Complete (EP) 1set</p>  <p>FTX6266</p>	<p>Slipper Pad (EP) 2pc</p>  <p>FTX6267</p>	<p>Slipper Gasket (EP) 2pc</p>  <p>FTX6268</p>	<p>65T Spur Gear (EP) 1pc</p>  <p>FTX6275</p>
<p>Slipper Shaft (EP) 1pc</p>  <p>FTX6269</p>	<p>Slipper Spring Bracket (EP) 1pc</p>  <p>FTX6270</p>	<p>Slipper Spring (EP) 1pc</p>  <p>FTX6271</p>	<p>Slipper Coupler (EP) 1pc</p>  <p>FTX6272</p>
<p>Slipper Drive Cup 1pc</p>  <p>FTX6273</p>	<p>BEARING BRACKET (EP) 1pc</p>  <p>FTX6262</p>	<p>Pinion Gear 23T (EP) 1pc</p>  <p>FTX6278</p>	<p>Sway Bar 2Sets</p>  <p>FTX6375 (option)</p>
<p>EP Chassis plate 1pc</p>  <p>FTX6259</p>	<p>Rear Spur Gear Cover (EP) 1pc</p>  <p>FTX6260</p>	<p>Upper plate (EP) 1pc</p>  <p>FTX6261</p>	<p>Center Drive Shaft (EP) 1pc</p>  <p>FTX6265</p>

Part List

<p>Body Clip (Medium Size) 6pcs</p>  <p>FTX6550</p>	<p>Body Clip (Small Size) 6pcs</p>  <p>FTX6551</p>	<p>Shock Ball End 6pcs</p>  <p>FTX6500</p>	<p>Servo Link Ball End 6pcs</p>  <p>FTX6501</p>
<p>Steering Linkage Ball End 6pcs</p>  <p>FTX6502</p>	<p>Rear Upper Linkage Ball End 6pcs</p>  <p>FTX6503</p>	<p>Sway Bar Fix Plate 6pcs</p>  <p>FTX6504</p>	<p>Sway Bar Holders 6pcs</p>  <p>FTX6505</p>
<p>Ball A 6pcs</p>  <p>FTX6506</p>	<p>Ball B 6pcs</p>  <p>FTX6507</p>	<p>Ball C 6pcs</p>  <p>FTX6508</p>	<p>Ball D 6pcs</p>  <p>FTX6509</p>
<p>Shock O-ring (Lower) 6pcs</p>  <p>FTX6510</p>	<p>Diff O-ring Seal 6pcs</p>  <p>FTX6511</p>	<p>Shock O-ring (upper) 6pcs</p>  <p>FTX6512</p>	<p>Pin $\phi 2 \times 10$ 6pcs</p>  <p>FTX6513</p>
<p>Pin $\phi 2 \times 11$ 6pcs</p>  <p>FTX6514</p>	<p>Hinge Pins (long & short) 1sets</p>  <p>FTX6223</p>	<p>Ball Bearing 15*10*4 6pcs</p>  <p>FTBB10</p>	<p>Ball Bearing 10*5*4 6pcs</p>  <p>FTBB16</p>
<p>Ball Bearing 8*5*2.5 6pcs</p>  <p>FTBB14</p>	<p>E clip-8mm 4pc</p>  <p>FTX6515</p>	<p>E clip-4mm 6pc</p>  <p>FTX6516</p>	<p>E clip-2.5mm 6pc</p>  <p>FTX6517</p>

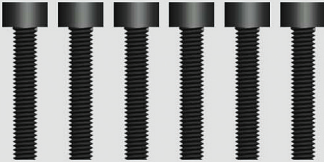
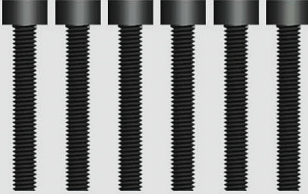
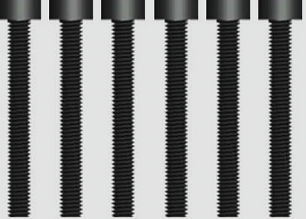
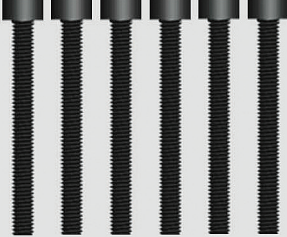
Part List

<p>Nylon Lock Nut M3 6pc</p>  <p>FASTM3</p>	<p>Nylon Lock Nut-M4 6pc</p>  <p>FASTM4</p>	<p>Round Head Self Tapping Hex Screw 2*6 4pcs</p>  <p>FTX6518</p>	<p>Round Head Self Tapping Hex Screw 2*10 6pc</p>  <p>FTX6519</p>
<p>Round Head Self Tapping Hex Screw 3*15 8pc</p>  <p>FTX6520</p>	<p>Round Head Self Tapping Hex Screw M3*6 6pc</p>  <p>FTX6522</p>	<p>Button Head Hex Screw M3*8 6pc</p>  <p>FTX6525</p>	<p>Button Head Hex Screw M3*10 6pc</p>  <p>FTX6526</p>
<p>Button Head Hex Screw M3*12 6pc</p>  <p>FTX6527</p>	<p>Button Head Hex Screw M3*14 6pc</p>  <p>FTX6528</p>	<p>Ring Self Tapping Screw 3*4 4pc Ring Self Tapping Screw 3*6 6pc</p>  <p>FTX6530 FTX6531</p>	<p>Set Screw M3*3 6pc</p>  <p>FAST122</p>
<p>Set Screw M4*4 6pc</p>  <p>FAST123</p>	<p>Button Head Hex Screw M4*10 6pc</p>  <p>FTX6543</p>	<p>Cap Head Hex Screw M3*8 6pc</p>  <p>FAST114</p>	<p>Cap Head Hex Screw M3*10 6pc</p>  <p>FTX6542</p>
<p>Cap Head Hex Screw M3*10 6pc</p>  <p>FAST115</p>	<p>Cap Head Hex Screw M3*14 6pc</p>  <p>FTX6532</p>	<p>Cap Head Hex Screw M3*15 6pc</p>  <p>FAST117</p>	<p>Cap Head Hex Screw M3*18 6pc</p>  <p>FAST118</p>
<p>Cap Head Hex Screw M3*25 6pc</p>  <p>FAST119</p>	<p>Cap Head Hex Screw M3*28 6pc</p>  <p>FTX6533</p>	<p>Flat Head Hex M3*8 6pc</p>  <p>FTX6535</p>	<p>Flat Head Hex Screw M3*10 8pc</p>  <p>FTX6536</p>

Part List

<p>Flat Head Hex Screw M3*12 6p</p>  <p>FTX6537</p>	<p>Flat Head Hex Screw M3*14 6p</p>  <p>FTX6538</p>	<p>Flat Head Hex Screw M3*18 3p</p>  <p>FTX6539</p>	<p>Flat Head Hex Screw M3*20 6p</p>  <p>FTX6540</p>
<p>Flat Head Hex Screw M3*36 6p</p>  <p>FTX6541</p>	<p>AM Transmitter 1pc AM RX 1pc</p>  <p>ET6555</p>	<p>2.4GHz Transmitter 1pc ET1060</p>  <p>Receiver ET1095</p>	<p>Brushless ESC 1pc</p>  <p>ET0110</p>
<p>300A ESC 1pc</p>  <p>FTX6557</p>	<p>3650 Brushless Motor 1pc</p>  <p>ET0332</p>	<p>550 Brushed Motor 1pc</p>  <p>FTX6558</p>	<p>Ni-MH 7.2V 1800mAh 1pc</p>  <p>VZ0010</p>
<p>3kg/cm Servo 1pc</p>  <p>FTX6559</p>	<p>Clear Body (EP) 1pc</p>  <p>FTX6280</p>	<p>Printed Body (EP) 1pc</p>  <p>FTX6281</p>	<p>Printed Body (EP) 1pc</p>  <p>FTX6282</p>
<p>Printed Body (EP) 1pc</p>  <p>FTX6283 (option)</p>	<p>Buggy Tail Wing (Black) 1pc FTX6285</p> <p>Buggy Clear Tail Wing 1pc FTX6286</p> 	<p>Li-Po 2500mAh 7.4V 1pc</p>  <p>VZ0304</p>	<p>1/10 Charger 1pc</p>  <p>ET0220</p>
<p>LiPO Balance Charger ET0219</p> 			

Upgrade Parts List

<p>Front Shock Plate (carbon) 1 set</p>  <p>FTX6351</p>	<p>Rear Shock Plate (carbon) 1 set</p>  <p>FTX6352</p>	<p>Battery cover (carbon) 1 set</p>  <p>FTX6354</p>	<p>Body Post (Al.) 2 pcs</p>  <p>FTX6355</p>
<p>Front Shocks (Al.) 2 pcs</p>  <p>FTX6356</p>	<p>Rear Shocks (Al.) 2 pcs</p>  <p>FTX6357</p>	<p>Steering Ackerman (Al.) 1 pc</p>  <p>FTX6360</p>	<p>Front Susp. Holders (Al.) 1 set</p>  <p>FTX6361</p>
<p>Rear susp. holders (Al.) 1 set</p>  <p>FTX6362</p>	<p>Rear hub carrier (Al.) 2 pcs</p>  <p>FTX6363</p>	<p>Steering Knuckle Arm (Al.) 1 set</p>  <p>FTX6364</p>	<p>Wheel Hub (Al.) 4 pcs</p>  <p>FTX6365</p>
<p>Heatsink 1 pc</p>  <p>FTX6373</p>	<p>Wheelieset 1 set</p>  <p>FTX6366</p>	<p>Aluminium Steering Arms 2 pcs</p>  <p>FTX6367</p>	<p>Alum. Knuckle Arm 2 pcs</p>  <p>FTX6368</p>
<p>Chassis Plate (Al. + carbon) 1 set</p>  <p>FTX6369</p>	<p>Upper Plate (carbon) 1 pc</p>  <p>FTX6370</p>	<p>Front lower susp. arm (Al.) 2 pcs</p>  <p>FTX6371</p>	<p>Rear lower susp. arm (Al.) 2 pcs</p>  <p>FTX6372</p>

VANTAGE



www.ftx-rc.com



FTX is an exclusive brand of CML Distribution, Saxon House, Saxon Business Park,
Hanbury Road, Bromsgrove, Worcestershire, B60 4AD England.
E-mail: info@ftx-rc.com